

Plan

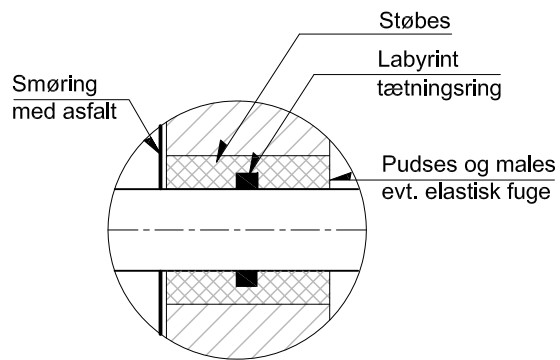

Detalje 1

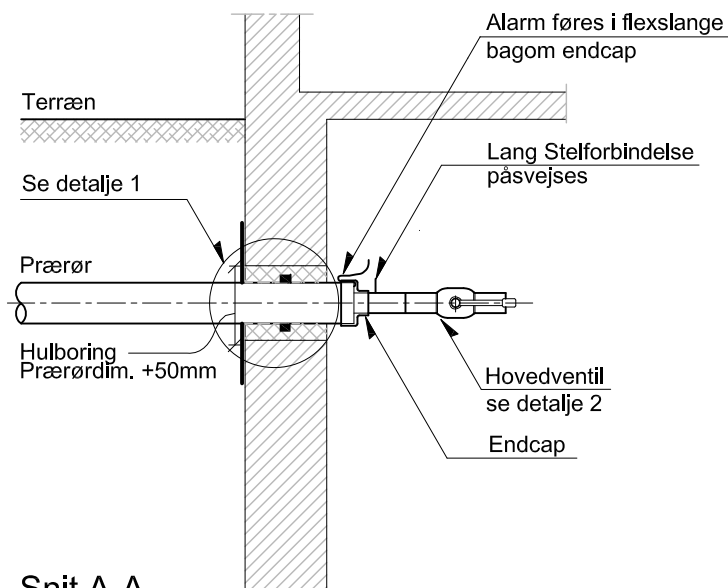

Snit A-A

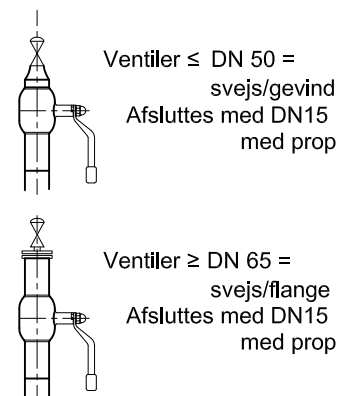

Design tryk	Flange PN
6	25
10	25
16	25
25	40

Detalje 2

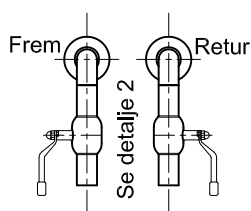

Snit B-B

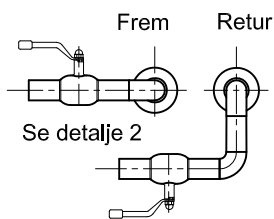

Snit C-C

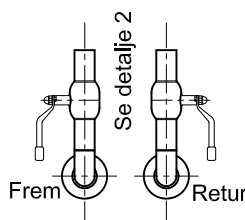

Snit D-D

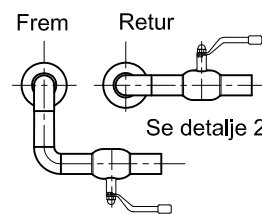

Snit E-E

VEKS ENERGI TIL DIG PÅ VESTEGNEN

Roskildevej 175, 2620 Albertslund +45 43 66 03 66 www.VEKS.dk



Rev. Dato Konst./Tegn. Kontrol. Godk.
2016-06-01 HST/PETU PLU PETU

Projekt 1100009548 Mål Alle ubenævnte mål er i mm

Tilslutningsdiagram for kundeinstallationer

Stikindføring i kælder -
Enkeltrør

Fil
Tegning nr.

FN-000_F-001-A